



USB 2.0 & 3.0 CAMERAS

WI-FI CAMERAS

FULL HD CAMERAS

TABLET SOLUTIONS

Motic[®]

MORE THAN MICROSCOPY



MOTICAMSERIES

Product Range Catalogue



MOTICAM

For the past 15 years, Motic has been pioneering attachable digital microscopy solutions that continue to revolutionize the way even old microscopes can be reborn.

Starting out with very humble VGA resolution all those years ago, we are now looking at the Moticam 10+ with a whopping 10 MP of live imaging through high speed USB3 connections. Whether it is Wi-Fi, HDMI, USB3 or SD card, there is a way for you to share data that exactly fits your need.

Your Motic Europe Team





THE [AllinOneBOX] CONCEPT

Always listening to our end-users, each of the Moticam you will find in this booklet is packed with tools that you - the user - will find not only useful, but perfectly fitted to your needs. This means that the Moticams are probably the only All-in-One Box digital microscopy solution available at that price.

Having the epithet All-in-One Box means that with each Moticam you will get the tools and the software to immediately start turning your microscope into a digital workstation.

As you browse this catalogue, you will find that the flexibility is not only in the possibility to attach the cameras to almost any microscope, but also in being able to deliver a powerful software application suite to almost any platform.

SEE WHAT YOUR MOTICAM BOX INCLUDES

AN ATTACHABLE CAMERA



containing a sensitive professional imaging chip housed inside a C-Mount case including a removable IR cut-off filter

A FOCUSABLE COATED GLASS LENS



matched to the size of the imaging chip

TWO ADJUSTABLE SIZE EYEPIECE ADAPTERS



that allow you to attach the camera onto almost any microscope without having to remove the eyepiece

A 4-DOT CALIBRATION SLIDE



with micrometer cross-hairs that ensures accurate calibration for precise measurements

A MACRO VIEWING TUBE



that used together with the focusable lens is ideal for using the camera without a microscope

ALL NECESSARY CABLES



and power supplies

A FULL VERSION OF MIP 3.0 APPLICATION SOFTWARE



provides all you need to quantify, measure, annotate, teach, learn...and much more

P.06-09 | USB 2.0 & 3.0 CAMERAS

P.10-11 | WI-FI CAMERAS



USB 2.0 & 3.0 CAMERAS

WI-FI CAMERAS



Radius: 976.86 μm
Area: 3010171.75 μm^2
Perimeter: 6150.35 μm

Radius: 730.70 μm
Area: 1677360.00 μm^2
Perimeter: 4591.11 μm

P.16-17 | SOFTWARE - MOTICONNECT APP & MIP 3.0

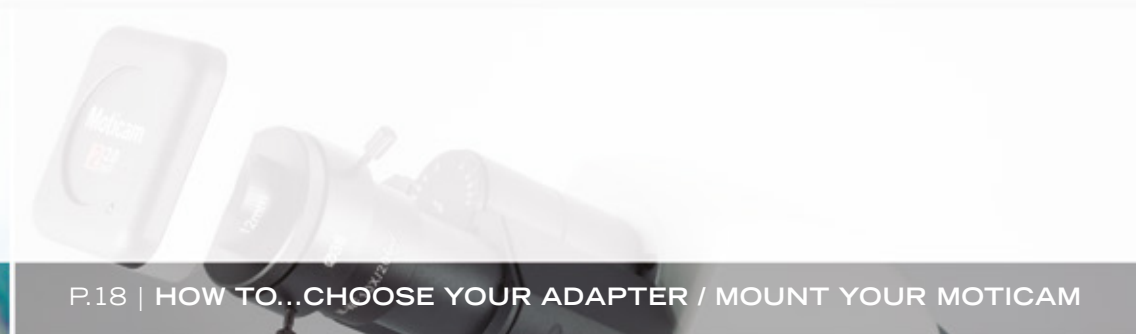

P.18 | HOW TO...CHOOSE YOUR ADAPTER / MOUNT YOUR MOTICAM

P.12-13 | FULL HD CAMERAS

P.14-15 | TABLET SOLUTIONS



P.13

P.13

FULL HD CAMERAS



P.15

P.15

TABLET SOLUTIONS

P.19-21 | UNDERSTANDING OUR CAMERAS

P.22-23 | TECHNICAL DATA CHART

USB

2.0 & 3.0 CAMERAS

The USB (Universal Serial Bus) connection is probably the most common peripheral connection to a computer. Now at USB3 speed, it makes fast dataflow and high resolution live imaging possible without having to rely on low frame rates or high exposure rates.

Our USB Moticams use standard USB2 and USB3 cables so even in the event that such a cable would get lost or damaged, buying a replacement is a simple and cost effective task.



- MOTICAM 1
- MOTICAM 2
- MOTICAM 3+
- MOTICAM 5+
- MOTICAM 10+





Moticam¹

A simple and efficient way to get started with attachable digital microscopy at a good price. At a live image resolution of 1280x720 pixels, the Moticam 1 is enough for making your microscope come alive in a classroom, laboratory or even in your own home. Simple to setup and simple to use, with the included focusable lens and eyepiece adapters, the Moticam 1 is quick to setup and ready to go.

Moticam²

If you are after more live resolution, the Moticam 2 offers the same features of the Moticam 1 but at a live resolution of 2 MP. This camera is perfect for those who seek more details in their images or those who want to display the live image on a full computer screen.



Moticam 3+

Our most popular camera, the 3 MP live resolution imaging device is the first in our line-up to benefit from high-speed USB3 data transmission. Although it is backward compatible with older USB ports, if your system has a USB3 interface, you will be able to enjoy fast streaming images directly from your microscope. As with other Moticams, the Moticam 3+ comes with adapters and tools to fit onto almost any microscope.

Pictures taken with a Moticam 3+ and...

- 1 SMZ171 stereo microscope
- 2 BA410E upright microscope
- 3 BA310MET upright microscope

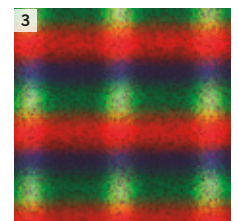
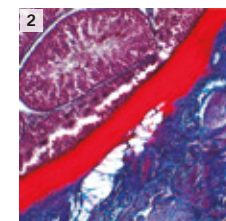
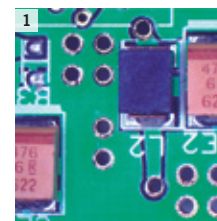



Moticam**5+** Moticam**10+**

On the higher end of the resolution scale are our Moticam 5+ and 10+ with 5 MP and 10 MP real-time live imaging resolution. For those who want to eke out the smallest of details, these high resolution live cameras will be the best choice. With greater resolution also comes greater printing possibilities.

For users who like to publish their findings and images in higher DPI settings, the 5 MP and 10 MP resolutions allow that possibility within one small package. Equipped with USB3 high speed data transfer, these two cameras provide the best of resolution and frame rates.

WI-FI CAMERAS

As good as USB or HDMI connections are, sometimes you just need to cut away from the wires and have a live image transmitted to your tablet, your computer or your phone wirelessly. As with all Moticams, proper image representation as well as quantification tools such as measurements and annotations are still kept available no matter what device you are using to view the live images.

Free applications are available for iOS, Android as well as Windows Mobile devices. Both cameras below come with our focusable lens, eyepiece adapters as well as full application software suite.





Moticam X

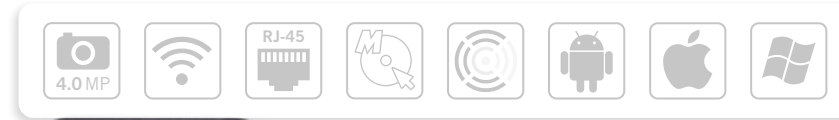

Moticam X3



Moticam X

The Moticam X is the first and most cost-effective wireless camera in our range. This camera gets its power from an attached USB cable; you can keep it powered from USB 5V power supply. By creating its own Wi-Fi access point, you can easily share the live image with several users on different platforms.

Moticam X³

For more demanding users, the Moticam X³ captures images at 4.0MP and it is much faster, transferring live images up to 30 fps. It also allows you to integrate it to your own network either via Wi-Fi or Ethernet cable, allowing more users to be connected. Alternatively, it also works with our standard Motic Images Plus Software for computers.

FULL HD

CAMERAS

High Definition monitors and televisions are common-place in many schools, labs and clinics. Motic has launched three models that feature uncompromised HDMI output directly to those screens.

With built-in image processing tools, simply connect your mouse to the camera and take full control over the image parameters and still or video capture modes.



MOTICAM 1080
MOTICAM 1080 BMH
MOTICAM 1080 INT





Moticam
1080

Moticam
1080BMH & INT

Moticam 1080

The Moticam 1080 has HDMI and USB outputs as well as a slot for an SD-card. Work with the 1080 without the need for a computer by connecting a wireless mouse and have all controls on screen. As with all other Moticams, you can use the Moticam 1080 with a computer. Simply use the USB connection and connect it straight to your PC for use with the supplied Motic Images Plus application software.

Moticam 1080BMH Moticam 1080INT

The 1080 BMH is a full HD station featuring an attached 11" HDMI screen. All the functions of the 1080 can be found on the 1080 BMH and controlled on its own HDMI screen making this a very efficient package for both stereo and compound microscopes. The 1080 INT has the same features as the 1080 BMH, but is meant to be used as an intermediate module for our well-known BA Series of upright microscopes.

TABLET SOLUTIONS

Bringing digital microscopy to the compact screens of tablets is Motic's focus in the foreseeable future. Tablets and other mobile devices are becoming common in schools, hospitals and at the workplace, therefore we have devised a few connection methods to allow a conversion of almost any microscope into a truly mobile digital microscopy platform.

In order to take full advantage of Motic's long history with affordable yet powerful solutions, our versatile software applications are now also ported to iOS, Android and Windows mobile devices therefore allowing you the freedom to choose how you wish to share your microscope.



MOTICAM BTX8
MOTICAM BTU10
MOTICAM BTW





Moticom
BTX8

Moticom
BTU10

Moticom
BTW

Moticom **BTX8**

The Moticom BTX8 combines a space-saving camera hardware with new Wi-Fi technology. The 4MP Wi-Fi camera comes together with an 8" Android tablet to deliver fast live images up to 30 fps. Detaching the tablet for an even more flexible application is possible thanks to the Wi-Fi data transfer.

Moticom **BTU10**

The Moticom BTU10 is a tablet microscopy solution, consisting of a customized 10" Android tablet connected to a microscopy imaging camera of 5MP. The android tablet is easily detachable and replaceable and is completely separate from the camera, therefore providing maximum flexibility.

Moticom **BTW**

The BTW system contains a 5MP microscopy camera with a Wi-Fi connection and a cradle which will hold a tablet up to 10", ready to be used with your own tablet. Simply download MotiConnect for either Android or iOS systems and connect to the camera using the wireless signal or to a computer via USB cable.



MOTICONNECT APP

More and more people are using mobile devices in all aspects of their lives, including work. Digital Microscopy should not be an exception to this trend. And for this reason, we have created MotiConnect that works with iOS, Android as well as Windows mobile devices.

MotiConnect allows you to view live camera streams, capture and measure, annotate and share your microscope image by simply touching the icons on your tablet. This application is popular amongst students, professors and professionals alike as it is easy to use and intuitive, even to tablet novices.



MotiConnect App

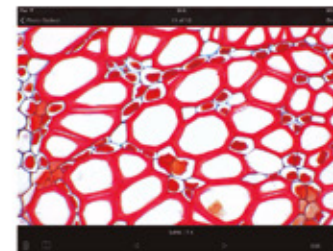



MOTIC IMAGES PLUS 3.0

This new software package is a complete rework of our popular Motic Images Plus 2.0. Having listened to feedback from end-users, we have packed as many useful features and tools as possible into this software suite while still keeping it organized, intuitive and easy to use. Best of all is its price tag. It is given free of charge to any Moticom purchase. That makes the Motic Images Plus 3.0 probably the most versatile and comprehensive free digital microscopy program in the market today.

With tools such as counting, annotations, live measurements and filters, this software package allows everyone to be able to quantify the images their microscope provides. Our dedicated software department is able to convert new ideas into software tools easily and therefore we provide periodic free of charge updates to the software. Have a good idea for new feature? Contact us anytime.

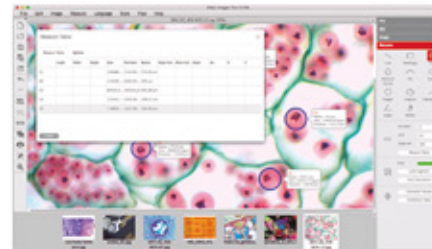
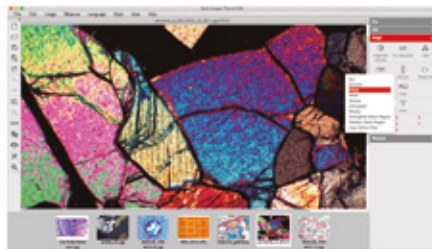
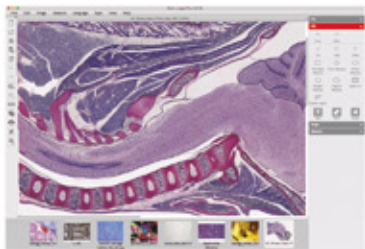

USB



Wi-Fi



Motic Images Plus 3.0
Image Analysis Software

IF YOU HAVE A MONOCULAR OR A BINOCULAR MICROSCOPE



Eyepiece coupler

The first option you have in case you have a monocular or a binocular microscope, is to mount the Moticam onto the eyepiece with the included eyepiece coupler that comes included in your Moticam box.

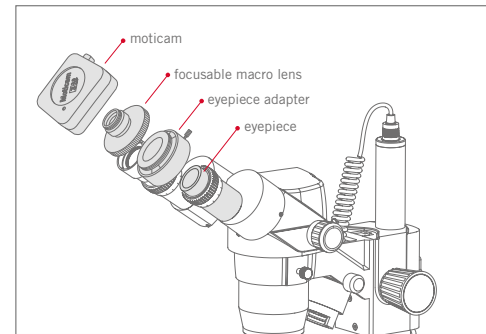

Onto the eyepiece

Attach the camera to the focusable macro lens and select the correct eyepiece coupler for your microscope. Put the complete combination onto the eyepiece.

IF YOU HAVE A TRINOCULAR MICROSCOPE



C- Mount adapter

The C-Mount adapter allows you to attach your camera to the trinocular port of your microscope, combining optical and mechanical tasks. The adapter has to be chosen in relation to the chip size of your camera, and it is brand and model specific. It has to be bought to your microscope supplier. Depending on the area of the FOV you wish to capture, you can choose among different magnification factors: 1X, 0.65X, 0.5X or 0.35X.

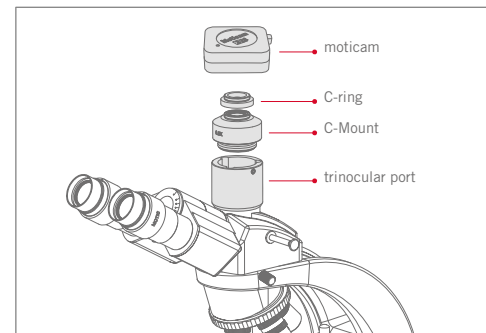

Onto the trinocular tube

Attach the Moticam to the C-Mount adapter and then fix it to the trinocular port. The C-Mount adapter needs to be chosen according to the chip size of the camera.

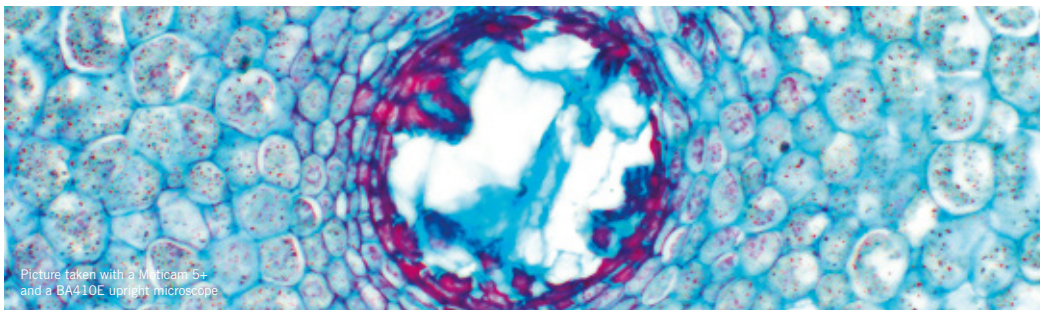

Picture taken with a Moticam 5+ and a BA410E upright microscope

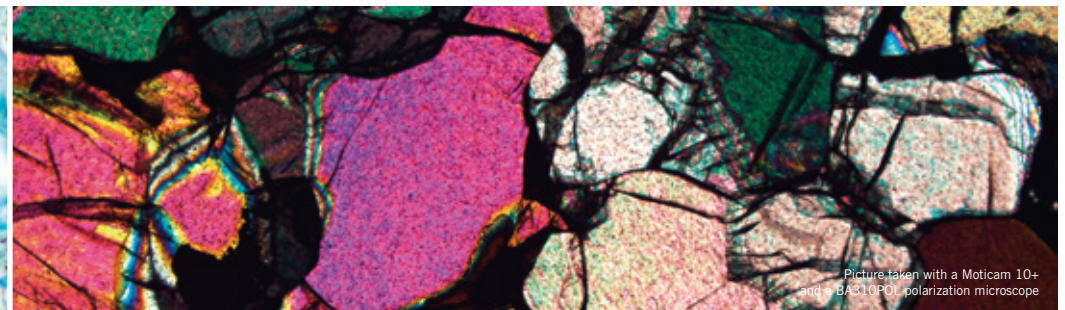

Picture taken with a Moticam 10+ and a BA310POL polarization microscope

UNDERSTANDING OUR CAMERAS... FIND YOUR WAY

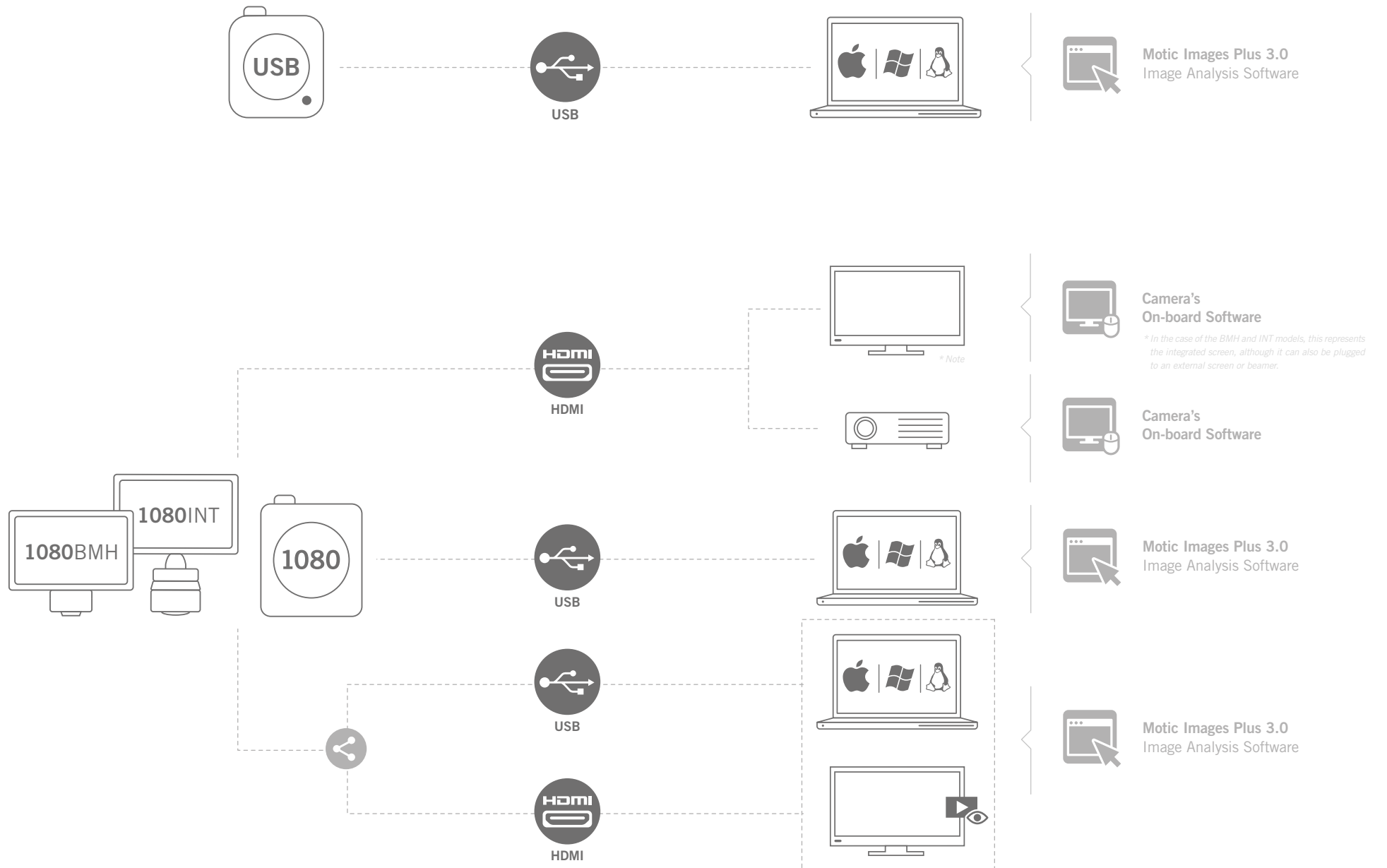

UNDERSTANDING OUR CAMERAS... FIND YOUR WAY

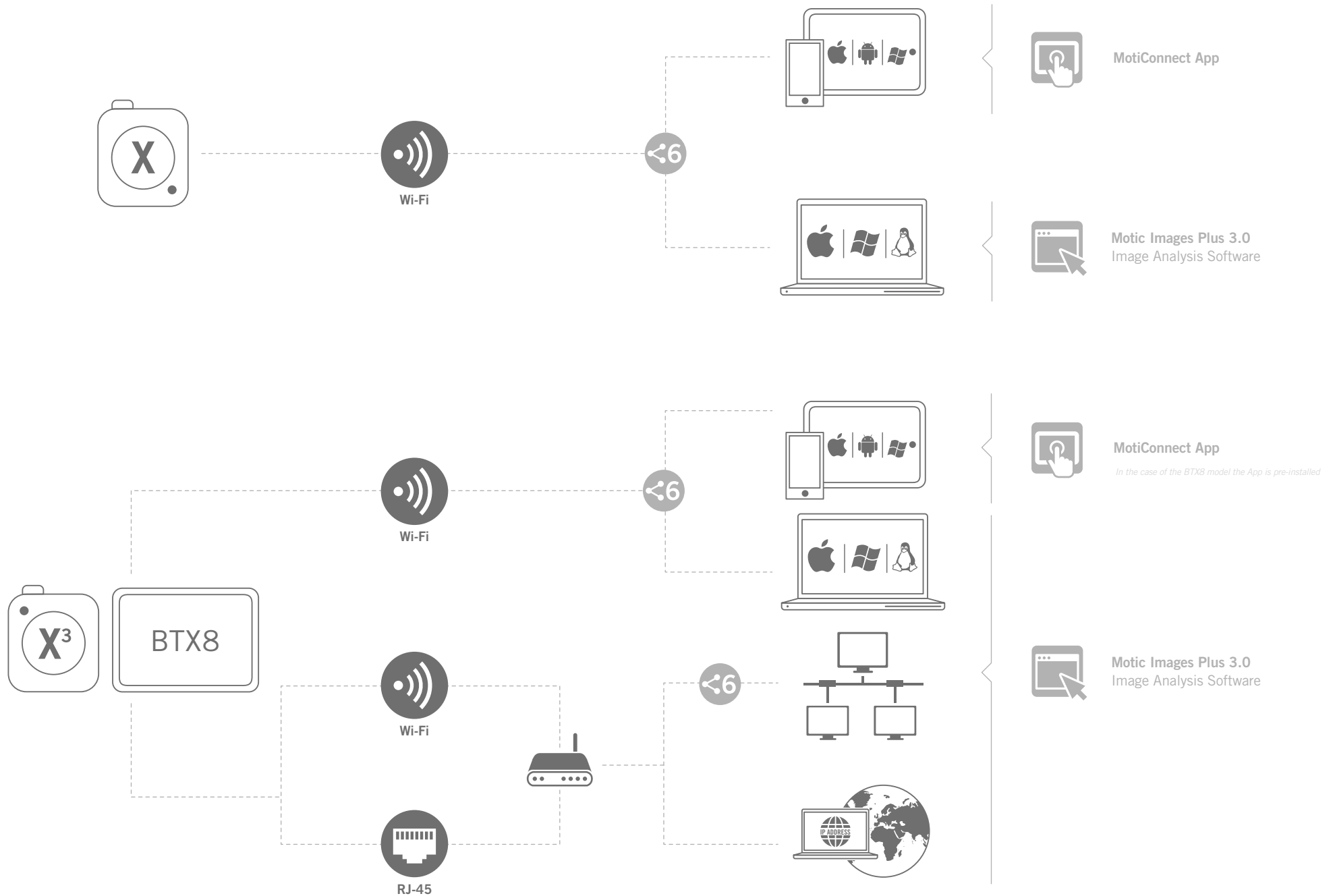

UNDERSTANDING OUR CAMERAS... FIND YOUR WAY

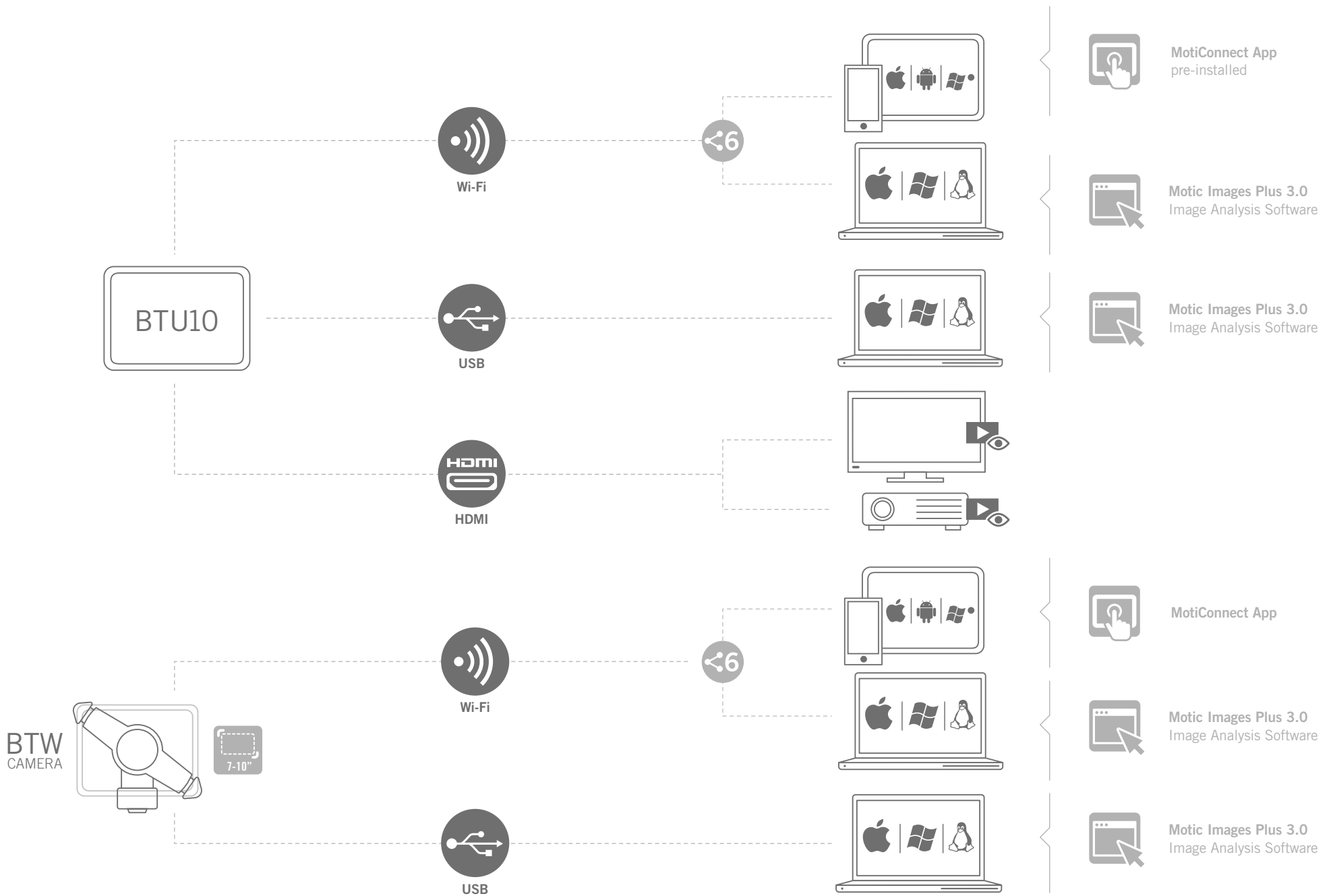

MOTICAM	1	2	3+	5+	10+	X	X ³
Sensor Type	CMOS	CMOS	CMOS	CMOS	CMOS	CMOS	CMOS
Sensor Size	1/2.9"	1/3"	1/2"	1/2.5"	1/2.3"	1/3.2"	1/3"
Capture resolution	1.0 MP	2.0 MP	3.0 MP	5.0 MP	10.0 MP	1.3 MP	4.0 MP
Live Display Mode (through USB)	1280 x 720	1600 x 1200 800 x 600 400 x 300	2048 x 1536 1024 x 768 512 x 384	2592 x 1944 1296 x 972 648 x 486	3664 x 2748 1832 x 1372 916 x 684	-	-
Live display mode (through Wi-Fi)	-	-	-	-	-	1280 x 960 (1.3 MP)	1920 x 1080 or 1280 x 720 (Wi-Fi & Ethernet)
Live Display Mode (through HDMI)	-	-	-	-	-	-	-
Pixel Size	4.20µm x 4.20µm	3.2µm x 3.2µm	3.2µm x 3.2µm	2.2µm x 2.2µm	1.67µm x 1.67µm	2.8µm x 2.8µm	2.0µm x 2.0µm
Data Transfer	USB 2.0	USB 2.0	USB 3.0	USB 3.0	USB 3.0	Wi-Fi	Wi-Fi and Ethernet (RJ45)
Frames per second (fps*)	1280 x 720 @ 30 fps	1600 x 1200 @ 5 fps 800 x 600 @ 20 fps 400 x 300 @ 24 fps	2048 x 1536 @ 12 fps 1024 x 768 @ 30 fps 512 x 384 @ 50 fps	2592 x 1944 @ 14 fps 1296 x 972 @ 30 fps 648 x 486 @ 50 fps	3664 x 2748 @ 7 fps 1832 x 1372 @ 14 fps 916 x 684 @ 48 fps	Up to 8 fps depending on Wi-Fi strength	1920 x 1080 Up to 30 fps 1280 x 960 Up to 30 fps depending on Wi-Fi strength
Exposure Time	-	0,09 msec to 6 sec	0,11 msec to 7 sec	0,15 msec to 5 sec	0,16 msec to 10 sec	0,05 msec to 0,07 sec	0,03 msec to 0,03 sec
Slot	-	-	-	-	-	-	-
Support Device	TWAIN and Direct Show Driver	TWAIN, SDK and Direct Show Driver				Universal Webbrowser (HTML5)	
Supported OS	Microsoft Windows 7/8/10 and MAC OSX & Linux		Microsoft Windows 7/8/10 and MAC OSX & Linux			Microsoft Windows 7/8/MAC OSX/ Android 4,0 or higher/iOS7 or higher/Windows Mobile	
Minimum Computer Requirements	2GHz dualcore - RAM memory 2GB - Video memory min. 512 MB						
Lens Mount	C-Mount						
Focusable Lens	12mm	12mm	16mm	12mm	12mm	12mm	12mm
Screen	-	-	-	-	-	-	-
Software	Motic Images Plus 3.0					MotiConnect App (free download)	
Power supply	5V (USB - supply)						5V (External Power supply)
Package Includes	CS Ring Adaptor, Focusable Lens, 30mm and 38mm Eyepiece Adapters, USB 2.0 (Moticam 1,2,X and X ³) or 3.0 Cable (Moticam 3+, 5+ and 10+), Calibration Slide, Macro Tube, Motic Images Plus 3.0 for PC/OSX/Linux						

WHICH MOTICAM FITS YOUR NEEDS? WWW.MOTICAMSERIES.COM

1080	1080 INT	1080 BMH	BTX8	BTU10	BTW	MOTICAM
CMOS	CMOS	CMOS	CMOS	CMOS	CMOS	Sensor Type
1/2.8"	1/2.8"	1/2.8"	1/2.5"	1/2.5"	1/2.5"	Sensor Size
Still Image: 8.0MP (3840 x 2160) / Video: Full HD 1920 x 1080			4.0MP	5.0MP	Through Wi-Fi: 1.3 MP / Through USB: 5.0 MP	Capture resolution
1920 x 1080 (Full HD)			1280 x 800 (display resolution)		Depending on tablet	Live Display Mode (through USB)
-	-	-	1920 x 1080, 1280 x 720 (display resolution)	-	1280 x 960 (1.3 MP)	Live display mode (through Wi-Fi)
1920 x 1080 (Full HD)			720P (HD)		-	Live Display Mode (through HDMI)
2.8µm x 2.8µm			2.2µm x 2.2µm			Pixel Size
HDMI (1080p) and USB 2.0			Wi-Fi and Ethernet (RJ45)	USB	USB or Wi-Fi	Data Transfer
USB: 1920 x 1080 (Full HD) @ 30 fps HDMI: 1920 x 1080 (Full HD) @ 60 fps			1920 x 1080 Up to 30 fps 1280 x 960 Up to 30 fps depending on Wi-Fi strength	1280 x 1024 @ 10 fps (USB) 1280 x 720 @ 10 fps (USB) 800 x 600 @ 20 fps (USB)		Frames per second (fps*)
0.06ms ~ 40ms with Auto Exposure mode (0.06ms ~ 999ms with Manual Exposure mode)			0,03 msec to 0,03 sec	0,09 msec to 6 sec		Exposure Time
SD Card (max 32Gb)			-	-	-	Slot
Twain and Direct Show Driver			Universal Web browser (HTML5)	-	Universal Web browser (HTML5)	Support Device
Microsoft Windows 7/8/10 and MAC OSX & Linux			Microsoft Windows 7/8/MAC OSX/ Android 4,0 or higher/iOS7 or higher			Supported OS
2GHz dualcore - RAM memory 2GB - Video memory min. 512 MB						Minimum Computer Requirements
C-Mount	-	-	C-Mount			Lens Mount
12mm	-	-	-	-	-	Focusable Lens
-	11.6" Native 1920 x 1080 Full HD screen with bracket		8" IPS Tablet	10" IPS Tablet	-	Screen
On-board software			MotiConnect App (pre-installed)		MotiConnect App (free download)	Software
12V (External Power supply)			5V (External Power supply)			Power supply
CS Ring Adaptor, HDMI cable, Focusable Lens (1080 only), 30mm and 38mm Eyepiece Adapters, USB 2.0 Cable, Calibration Slide, Macro Tube, Motic Images Plus 3.0 for PC/OSX/Linux			MicroSD 16Gb, HDMI Cable, USB 2.0 Cable, Motic Images Plus 3.0, Motic 4-dot calibration slide, Charger 100V-240V (CE)		USB 2.0 Cable, Motic Images Plus 3.0, calibration slide, Universal Power Supply 100V-240V (CE)	Package Includes
For tablets from 7" to 10"						Tablet bracket holder
Included					Not included. Users can use their own tablet and connect through Wi-Fi	
209 x 126 x 9.9 mm			263 x 173 x 9.5 mm		-	Size
Android 5.1			Android 5.1		-	System
1.3GHz Quad core			1.9GHz Quad core		-	CPU
1GB DDR3 / 8GB			2GB DDR3 / 16GB		-	RAM / NAND FLASH
8" (IPS) 16:10 Ratio / 1280 x 800 (IPS)			10.1" (IPS) 16:10 Ratio / 1280 x 800 (IPS)		-	Display / Display resolution
MicroSD/MMC/TF Card (Support up 32 GB), DC 5V Power Input, HDMI output,..						Ports



Motic®

Canada | China | Germany | Spain | USA

www.moticamsseries.com | www.moticeurope.com

EN | ES | FR | DE | IT | PT

Motic Instruments (Canada)

130 - 4611 Viking Way, Richmond, BC V6V 2K9 Canada
Tel: 1-877-977 4717 | Fax: 1-604-303 9043

Motic Deutschland (Germany)

Christian-Kremp-Strasse 11, D-35578 Wetzlar, Germany
Tel: 49-6441-210 010 Fax: 49-6441-210 0122

Motic Hong Kong (Hong Kong)

Unit 2002, L20, Tower Two, Enterprise Square Five, 38 Wang Chiu Road, Kowloon Bay, Kowloon
Tel: 852-2837 0888 | Fax: 852-2882 2792

Motic Europe (Spain)

C. Les Corts 12, Pol. Ind. Les Corts. 08349 Cabrera de Mar, Barcelona, Spain
Tel: 34 93 756 62 86 | Fax: 34 93 756 62 87

*CCIS® is a trademark of Motic Incorporation Ltd.

Motic Incorporation Limited Copyright © 2002-2018. All Rights Reserved.

Design Change: The manufacturer reserves the right to make changes in instrument design in accordance with scientific and mechanical progress, without notice and without obligation.

Designed in Barcelona (Spain)

Updated: December 2018

Official Distributor:





Canada | USA | Europe | China



www.moticmicroscopes.com

Motic Instruments, Inc. (Canada)

130-4611 Viking Way, Richmond, BC V6V 2K9 Canada
Tel: 1-877-977-4717 | Fax: 1-604-303 9043
info@motic-america.com

Motic Instruments USA Inc.

6508 Tri-County Parkway Schertz, TX 78154 USA
Tel: 1-800-275-3716

Motic Europe (Spain)

C. Les Corts 12, Pol. Ind. Les Corts. 08349 Cabrera de Mar, Barcelona, Spain
Tel: 34-93-756 6286 | Fax: 34-93-756 6287

Motic Incorporation Ltd. (Hong Kong)

Unit 2002, L20, Tower 2, Enterprise Sq. 5, 38 Wang Chiu Rd, Kowloon Bay, Kowloon
Tel: 852-2837 0888 | Fax: 852-2882 2792

Design Change: The manufacturer reserves the right to make changes in instrument design in accordance with scientific and mechanical progress, without notice and without obligation.

Motic Incorporation Limited Copyright © 2002-2019. All Rights Reserved.

Updated: October 2019

