

NF 1.300

DIAPHRAGM LIQUID PUMP



NF 1.300 KP.27DCB

ADVANTAGES

- Self priming and excellent for pressure
- Extreme chemical resistance
- Dry running and durable
- Low maintenance
- Available with integrated overpressure relief valve (version .27)

POSSIBLE AREAS OF USE

- Analysers
- Laboratory
- Cleaning industry
- Printing

Please visit our website
www.knf.com
 to get more information.

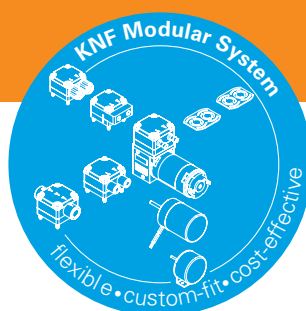

PERFORMANCE DATA					
Series model	NF 1.300 DC				NF 1.300 DCB
Material options	KP	KT	TT	FT	
Pump head	PP	PP	PVDF	PTFE	
Diaphragm	PTFE	PTFE	PTFE	PTFE	
Valves	EPDM	FFKM	FFKM	FFKM	
Flow rate at atm. pressure (l/min)	3				
Suction height (mWg)	3				
Pressure head (mWg)	60				
Permissible ambient air (°C)	5 to 40				
Permissible liquid temperature (°C)	5 to 80				
Weight (kg)	1				1
IP protection factor	50				54
ELECTRICAL DATA					
Operating voltage (V)	12 / 24				12 / 24
Power consumption (W)	34 / 34				35 / 35
I load max. (A)	2.8 / 1.4				2.5 / 1.66

NF 1.300 DC

PERFORMANCE DATA

Series model	Flow rate at atm. pressure (l/min)	Max. suction height (mWg)	Max. pressure head (mWg)
NF 1.300 DC	3	3	60

NF 1.300 DC

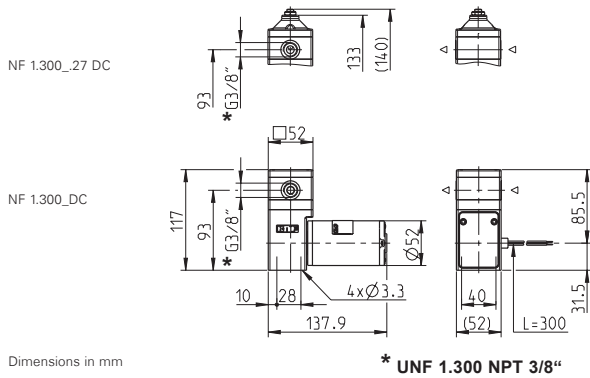

NF 1.300 DCB

PERFORMANCE DATA

Series model	Flow rate at atm. pressure (l/min)	Max. suction height (mWg)	Max. pressure head (mWg)
NF 1.300 DCB	3	3	60

NF 1.300 DCB

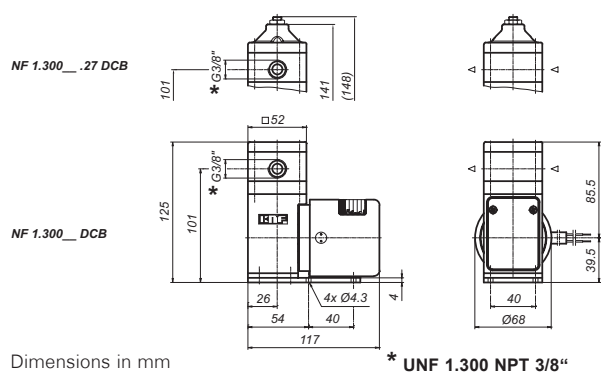

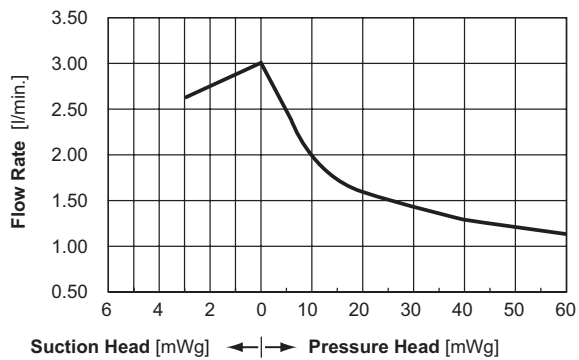

NF 1.300 DC FLOW CURVE

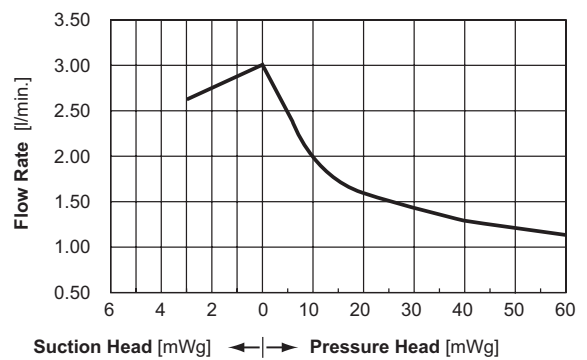

NF 1.300 DCB FLOW CURVE

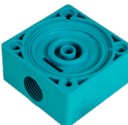

OPTIONS		
Description	Illustration	Details
Motors		Various voltage options, higher and lower service life
Electrical connections		Molex, AMP etc.
Hydraulic connections		G / NPT internal thread





NSF National Sanitary Foundation

This certification will confirm that all of the pumps with the code .51 are certified for the use with foods/consumables.



ATEX-explosion proof motors

For pumping liquids in explosive atmospheres we offer the NF 1.100 EX equipped with the KNF Ex-motor.

ACCESSORIES		
Description	Illustration	Details
Diaphragm pressure control valve (version .27)		The pressure control valve can be used for a more accurate control of flow against a fluctuating back pressure, metering into a vacuum and from a pressurised system.
Pulsation damper		This very versatile pulsation damper reduces the vibration in hoses and pipes and it helps to remove pulsation which is preventing the system from functioning correctly.

The performance values for the series models shown on this data sheet were determined under test conditions. The actual performance values may differ and depend in particular on the usage conditions and therefore on the specific application, on the parameters of the components involved in the user's system and on any technical modifications carried out which deviate from the standard configuration or the as delivered condition.

If individual designs have been created for specific customers on the basis of series models, other technical performance data may apply. Before operation begins, the relevant operating instructions and/or assembly or installation instructions should be read and the safety information contained in these instructions should be noted. KNF reserves the right to make changes to the product and the associated documentation without prior notice to the customer.



www.knf.com