



Handi+

INSTRUCTIONS FOR USE
SCUBA



NOTE: The latest edition of this operating manual can be downloaded from our website at www.maxtec.com

CLASSIFICATION

Protection against electric shock..... Internally powered equipment
 Protection against waterIPX4
 Mode of OperationContinuous
 Flammable anesthetic mixtureNot suitable for use in presence
 of a flammable anesthetic mixture



Product Disposal Instructions:

The sensor, batteries, and circuit board are not suitable for regular trash disposal. Return sensor to Maxtec for proper disposal or dispose according to local guidelines. Follow local guidelines for disposal of other components.

WARRANTY

Maxtec warrants to the original purchaser, that the HANDI+ analyzer to be free from defects in material and workmanship for a period of two-(2) years from the date of shipment from Maxtec or from one of Maxtec's authorized dealers. Parts found to be defective as determined by Maxtec, will be repaired or replaced free of charge if shipped prepaid to the factory in the original shipping carton. This warranty is void if the product has been subject to misuse or abuse, including but not limited to: exposure to water, humidity- temperature- shock or pressure outside of the listed specifications, or has not been operated in accordance with instructions, or if the identifying markings on the product label have been altered or removed. Routine maintenance items are excluded from this warranty. The seller assumes no liability for consequential damages of any kind, and the buyer, by acceptance through purchase of this product, will assume all liability for the consequences of its use or misuse by the buyer, his employees, or others. It is the sole responsibility of the buyer/user to determine if this product is suitable for the intended application.

WARNING

Indicates a potentially hazardous situation, if not avoided, could result in death or serious injury.

- ◆ The HANDI+ is not rated intrinsically safe nor is it designed for use in areas where flammable vapors are present.
- ◆ This device does not contain automatic barometric pressure compensation.
- ⊘ **DO NOT** use near any type of flame or flammable/explosive substances, vapors or atmosphere.
- ◆ The HANDI+ is a verification tool and should not be used to control the gas blending or process control applications.
- ◆ The HANDI+ should be disposed of properly in accordance with local regulations.

CAUTION







Indicates a potentially hazardous situation, if not avoided, could result in minor or moderate injury and property damage.

- ◆ Read the manual in its entirety before attempting use.
- ◆ Always use protective eye wear and observe proper safety procedures when working with pressurized gases.
- ◆ Always assure the pressure of gas entering the HANDI+ is 3 psig or less.
- ◆ Always calibrate the HANDI+ at an equivalent pressure and flow rate to the measured gas.

- ◆ Always calibrate the HANDI+ whenever the point of use elevation changes more than 500 feet (i.e.: Mexico City vs. San Diego,...).
- ◆ Dispose of the HANDI+ properly when it has expired.
- ◆ Ensure the protective freshness seal has been removed from the sensing port before use.
- ◆ Ensure the HANDI+ has been properly calibrated before use.
- ◆ If the HANDI+ display goes blank immediately after the on button is pushed, or the HANDI+ will not properly calibrate, the unit has expired.
- ⊘ **DO NOT** use, dispose of properly.
- ◆ The display is not valid when in Over Range Mode. Recalibrate the HANDI+ and observe the proper operating procedure.
- ◆ Never immerse the HANDI+ or expose it to high humidity or moisture. It is not watertight.
- ◆ Never expose the HANDI+ to high temperatures.
- ◆ Never expose the HANDI+ directly to unregulated gas lines, cylinder gas...These may contain high gas pressures which may cause the HANDI+ to rupture.
- ◆ There are no internal user-serviceable parts in the HANDI+.

SYMBOL GUIDE

The following symbols and safety labels are found on the Handi+:

| | | | |
|---|-----------------------------|---|---|
|  | Follow instructions for use |  | On/Off Button |
|  | Warning |  | Calibration Button |
|  | Meets ETL standards |  | Do not throw away. Follow local guidelines for disposal |
|  | Do Not |  | Manufacturer |
|  | Contains acid |  | Contains lead |
|  | Catalog Number |  | Serial Number |
|  | Lot code/Batch code |  | Ingress Protection Rating |

1.0 INTRODUCTION

1.1 Intended Use

In diving applications, different blends of oxygen may be used for breathing. Varying the concentration of oxygen in the breathing gas may be used to extend "bottom time", extend no-decompression time limits, or reduce the amount of time required for decompression. For safety reasons it is very important not to confuse a cylinder of air with a cylinder of enriched

oxygen. Mistaking compressed air for nitrox could lead to hazards such as nitrogen narcosis or decompression sickness.

The HANDI+ analyzer is a tool, which is well suited for identifying gas concentrations: air vs. 32% nitrox, 32% vs. 36% oxygen,... for example.

The HANDI+ is a convenient travel partner. It can be used to quickly identify the contents of cylinder gas obtained from unknown suppliers. The HANDI+ allows the diver to sort out cylinders, which may not have labels, or simply to verify those cylinders, which may be incorrectly labeled.

2.0 OPERATION

2.1 General

The plastic freshness seal on the sensing port should be removed and discarded when you are ready to use the HANDI+ for the first time. This seal ensured freshness of the HANDI+ during shipping and storage. Once the seal is removed, you should expect to obtain the normal life from the HANDI+. Included in the kit you will find the barbed adapter, which will screw onto the sensing port.

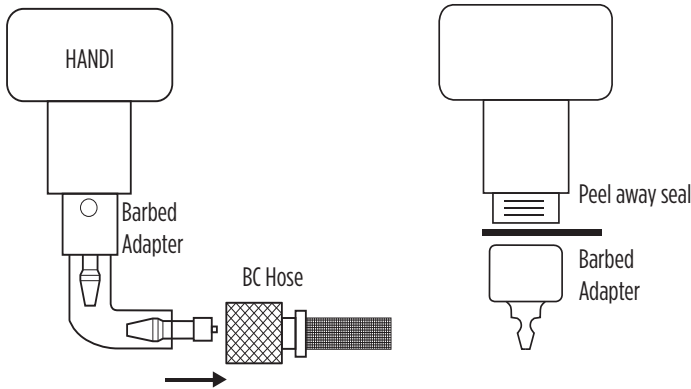

2.2 Low Pressure Port

The HANDI+ may be used to check the gas concentration directly at the hose leading to the Buoyancy Compensator (BC). The connection to the BC is normally through a quick connect type fitting. The hose fitting leading to the BC from the cylinder is a female quick connect. The BC has the male counterpart. Basically, a tube connection will be made from the hose to the HANDI+.

The HANDI+ has a male barbed fitting, which will adapt to a piece of 1/4" soft plastic tubing. It is recommended to use the Maxtec standard BC fitting for the connection from the HANDI+ to the BC hose. Allow some gas to pass through the barbed adapter and then observe the concentration of oxygen displayed.

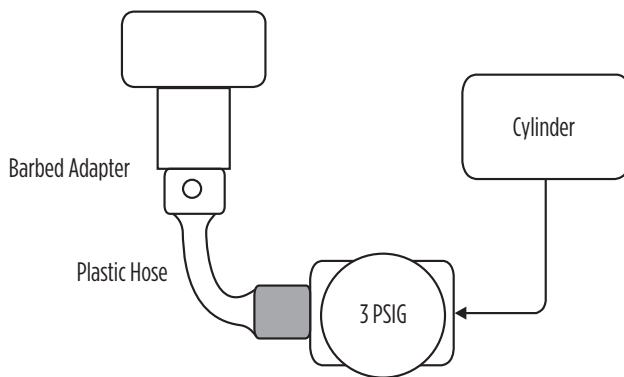

2.3 Working With High Pressures

The HANDI+ should never be connected to pressures greater than 3 psig. This could cause major failure of the sensing mechanism and may also cause the HANDI+ housing to rupture. The sample pressure must always be regulated down to the working pressure of the HANDI+ (0-3 psig). If you wish to measure the pressure directly at the high-pressure source, a suitable pressure regulator is required. The regulator must bring the gas entering the HANDI+ to 0-3 psig.

The HANDI+ has a male barbed fitting, which will adapt to a piece of 1/4" soft plastic tubing. The tubing can then be connected to the regulated pressure source. Allow some gas to pass through the barbed adapter and then observe the concentration of oxygen.

2.4 Atmospheric Pressure

In cases where it may be impractical to connect the HANDI+ directly to a regulated gas source, it is possible to take rough measurements at atmospheric pressure. For this application, unscrew the Barbed Adapter from the sensing port. Hold the HANDI+ up to the gas source (such as gas flowing from the cylinder to ambient air) and observe the oxygen concentration on the display.

This method is not the most accurate but may be improved by capturing the sample gas within a small plastic bag in which the HANDI+ is also located. Inflate the bag and take the reading. For this application, calibrate on ambient air.

2.5 Oxyknob Instructions for Use

1. Attach the Oxyknob adapter to the threaded sensor of your Maxtec analyzer.
2. Hand tighten until sensor o-ring seals against the Oxyknob.
3. Slowly crack open the tank. Listen for a slight hissing sound.
4. Hold the Oxyknob up to the outlet of the tank.
5. Align the small hole in the bottom or side of the Oxyknob to the hole in the outlet of the tank.
6. Hold the analyzer in place until the reading has stabilized on the analyzer display.
7. Remove the Oxyknob after reading and close valve on the tank.

WARNING: High gas pressures may cause damage to oxygen sensor and result in incorrect readings. Turn down the tank valve as much as possible to avoid sensor damage. Do not cover the larger holes on the Oxyknob.

WARNING: Cold gas exiting a pressurized tank can cause the sensor reading to drift if exposed for an extended period of time. Allow sensor to warm between readings if necessary.

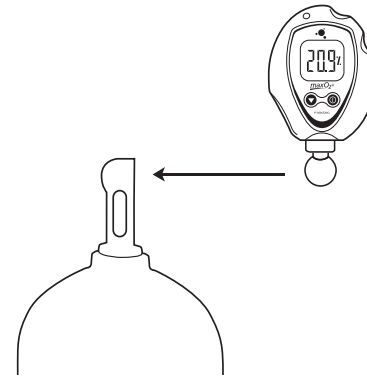

3.0 CALIBRATION

To simplify operation the Handi+ Analyzer automatically determines the calibration gas being used as compressed air (20.9%) or high grade (100%).

For best performance and accuracy, the HANDI+ should be calibrated on a frequent basis. It is preferable to calibrate each day it will be used or at least once a month on a known source of oxygen. Clean, dry compressed air is a suitable cal gas.

Compressed air should be easy to obtain and may be used as the calibration gas source. Normal clean dry air contains approximately 20.9% oxygen. Expose the HANDI+ to compressed air and push the "CAL" button . The display will indicate the concentration of oxygen of the Calibration gas. It is recommended that the HANDI+ be calibrated on compressed air at a pressure and flow-rate equivalent to the measured nitrox or gas blend. This may be accomplished by using the same gas sampling apparatus for calibration as for measuring. For example, if the HANDI+ is used with the low-pressure adapter when checking cylinders, use the same setup when calibrating (except use a cylinder filled with compressed air rather than the nitrox mix). After the display reads 20.9%, the HANDI+ is now calibrated and may be used to verify oxygen concentrations.

Always recalibrate the HANDI+ if the point of use elevation has changed by 500 feet. If the HANDI+ does not calibrate correctly to 20.9% or 100.0% Oxygen, the oxygen sensor has probably expired. Unit is at end of life.

4.0 CALIBRATION ERRORS & ERROR CODES

The Handi+ analyzers have a self test feature built into the software to detect faulty calibrations, oxygen sensor failures, and low operating voltage. These are listed below, and include possible actions to take, if an error code occurs.

EO3: No valid calibration data available

Make sure unit has reached thermal equilibrium. Press and hold the Calibration Button  for three seconds to manually force a new calibration.

EO4: Battery below minimum operating voltage

Unit is at end of life, refer to Product Disposal Instructions for proper disposal.

CAL Err St: O2 Sensor reading not stable

Wait for displayed oxygen reading to stabilize when calibrating the device at 100% oxygen. Wait for unit to reach thermal equilibrium (Please note that this can take up to one half hour, if the device is stored in temperatures outside the specified operating temperature range).

CAL Err lo: Sensor voltage too low

Press and hold the Calibration Button  for three seconds to manually force a new calibration. If unit repeats this error more than three times, contact Maxtec Customer Service.

CAL Err hi: Sensor voltage too high

Press and hold the Calibration Button  for three seconds to manually force a new calibration. If unit repeats this error more than three times, contact Maxtec Customer Service.

CAL Err Bat: Battery voltage too low to recalibrate

Unit is at end of life, refer to Product Disposal Instructions for proper disposal.

5.0 CLEANING, MAINTENANCE, & DISPOSAL

The HANDI+ analyzer requires little maintenance. For best performance and accuracy, the HANDI+ should be calibrated on a frequent basis. For general use, it is recommended the HANDI+ be calibrated once a month on a known source of oxygen such as clean dry (compressed) air. Reference the calibration section in this manual for more details.

If the unit becomes wet, it should be dried off immediately with a soft dry towel. The display may indicate low concentrations of oxygen if the sample port of the sensor becomes wet. In this case, remove the barbed adapter and thoroughly dry inside and out with a soft dry towel or cotton applicator tip. Additionally, dry the face of the sensor with a cotton applicator tip and allow to air dry for one half-hour (or until the oxygen display returns to normal). Exposure of the HANDI+ to water or extremely high RH may result in shortened life or cause the electronic circuit or battery to fail.

DISPOSAL: Please note the materials of construction for proper disposal. The material of the HANDI+ housing is a polycarbonate and ABS blend. The sensing portion of the HANDI+ contains lead and acetic acid. The HANDI+ contains a printed circuit board and a Lithium Battery.

6.0 SPECIFICATIONS

6.1 Analyzer Specifications

Sensor Type:.....Maxtec MAX-250 galvanic cell w/ Temperature Compensation (Non-Replaceable), Extra-Life Oxygen Sensor, galvanic cell type.

Measurement Range:.....0.0 - 100.0% oxygen (gas)

Resolution/Display:.....0.1%

The three digit LCD indicates values between 0.0 - 99.9% oxygen. Over range indicated by one decimal point on display located after the first digit.

Accuracy and Linearity:± 1% of full scale at constant temperature, R.H. and @ 15°C - 40°C pressure when calibrated at full scale. ± 3% actual oxygen level over full operating temperature.

Response Time:< 15 seconds for 90% step change. (at 25°C)

Warm-up Time:None required

Operating Temperature:.....15°C - 40°C (59°F - 104°F)

Storage Temperature:.....-15°C - 50°C (5°F - 122°F)

Operating Pressure:Atmospheric pressure to 3 psig.

Environmental:.....General purpose housing equivalent to NEMA 1.

The Handi+ is not waterproof. 0-95% RH, non-condensing.

Warranty:.....Twenty-four months in normal operating conditions.

Power Requirements:.....Powered by one internal, non-replaceable Lithium battery, CR2450.

Power on push button automatically shuts off after 80 seconds time-out.

Electronics rated general purpose; not for use in hazardous areas or for use with flammable gases.

Weight:.....Approx. 60 grams

Battery Life:.....Approx. 1850 hours (74,000 cycles)

Sample Port:.....M16 x1 Thread with barbed tubing adapter.

Operating Pressure:Atmospheric pressure to 3 psig

Expected Storage Life :.....Two months with freshness seal on sensor.

7.0 HANDI+ SPARE PARTS & ACCESSORIES

7.1 Standard Replacement Parts & Accessories

| PART NUMBER | ITEM |
|-------------|----------------|
| R218P16 | Scuba Handi+ |
| R106P01-005 | Barbed Adapter |
| R218M16 | Manual |
| R100P92-002 | Clear Tubing |
| RP76P06 | Lanyard |
| R218P09 | Handi+ Cover |
| R218P19 | OxyKnob |

ACCESSORIES:

Flow Diverter Fitting
(For use with medical tee)
#R110P10-001

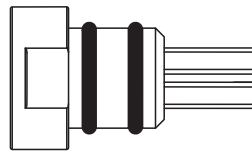

Standard BC Adaptor: #RP11P28

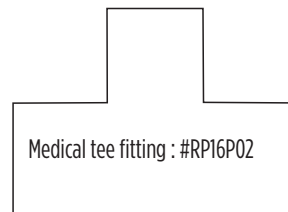
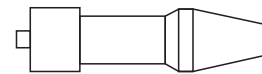

Medical tee fitting : #RP16P02

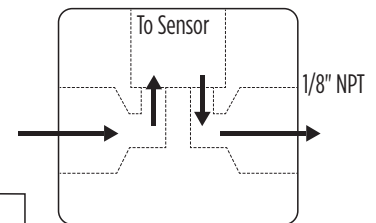

2305 South 1070 West
Salt Lake City, Utah 84119
(800) 748-5355
www.maxtec.com